

M125/FUG2-S FUGALI DRENAJ KANAL
M125/80 H2:50

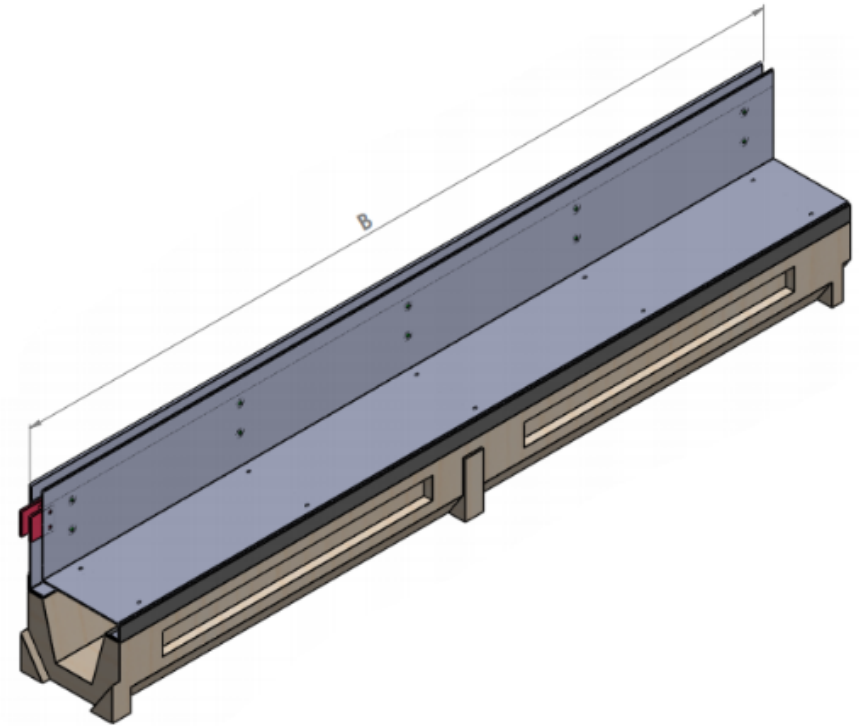

ÖLÇÜLER

A	B	H	H2
125	1000	80	50

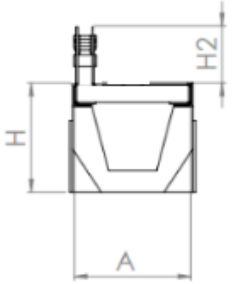
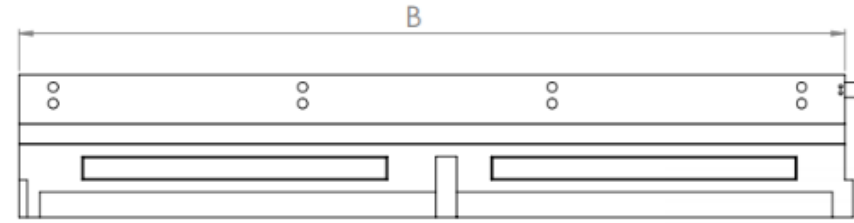