

M125/FUG2-S FUGALI DRENAJ KANAL
M125/150 H2:70

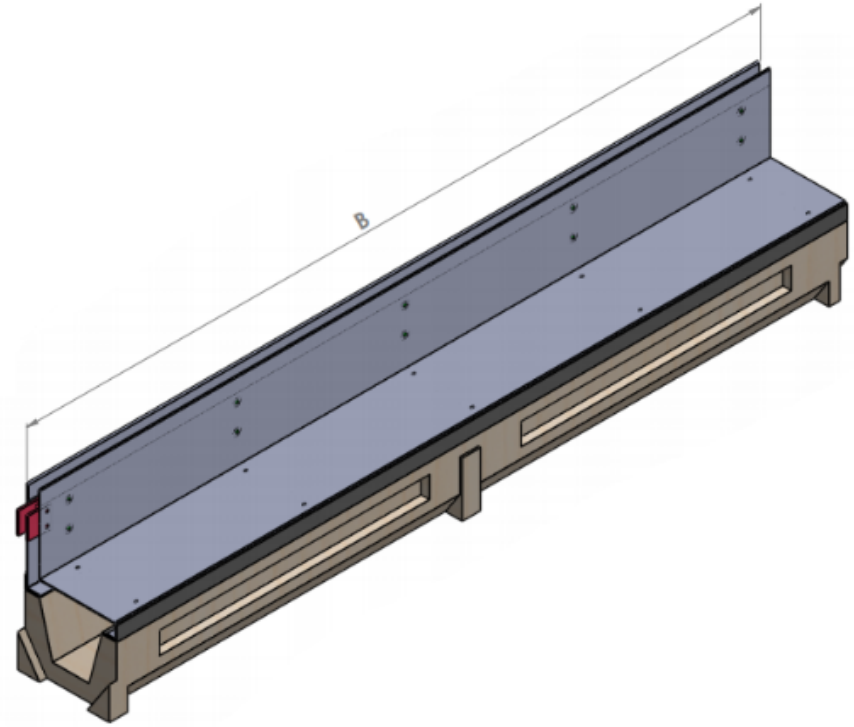

ÖLÇÜLER

A	B	H	H2
125	1000	150	70

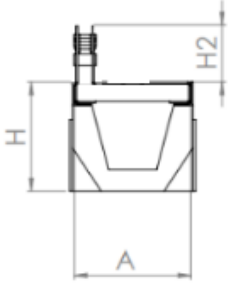
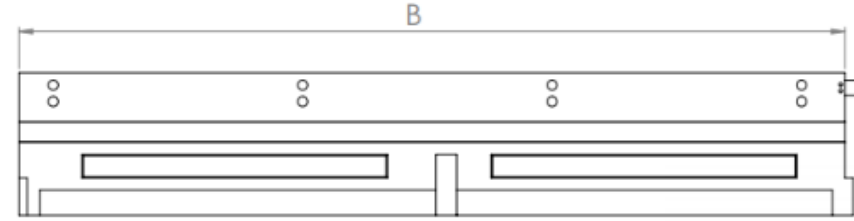